



CK40 A-AL-K-Y SERİSİ

CK40 A-AL-K-Y SERIE

CK60 A-AL-K-Y SERİSİ

CK60 A-AL-K-Y SERIE

CK80 A-AL SERİSİ

CK80 A-AL SERIE

PLASTİK AĞIR SERİ
PLASTIC HEAVY SERIE



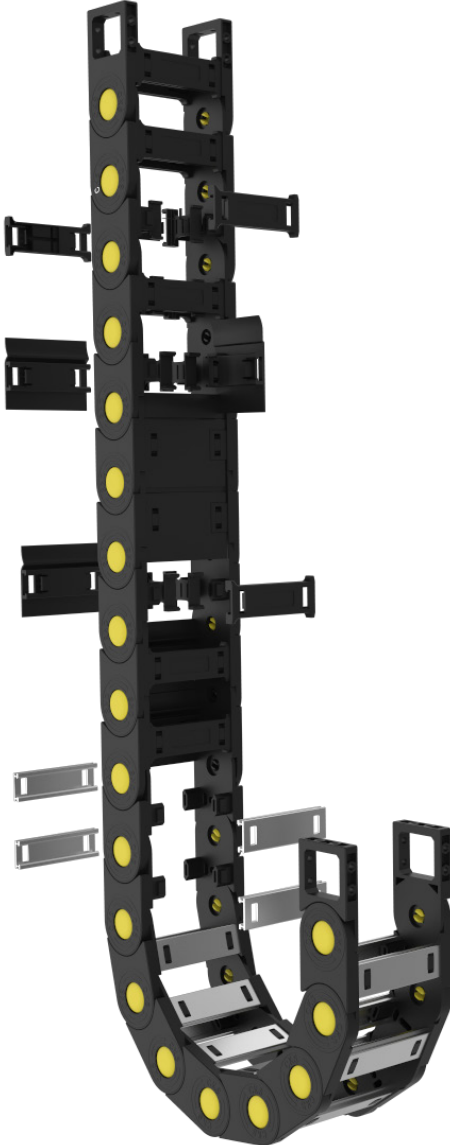

CK40 A SERİSİ
CK40 A SERIE

CK40 AL SERİSİ
CK40 AL SERIE

CK40 K SERİSİ
CK40 K SERIE

CK40 Y SERİSİ
CK40 Y SERIE

MALZEME ÖZELLİKLERİ

MATERIAL FEATURES

PA6 %30 Cam Elyaf
PA6 With %30 Fiber Glass

HIZ

SPEED

5 m/sn
5 m/sec

ÇALIŞMA SICAKLIĞI

OPERATING TEMPERATURE

-30°C ~ + 130°C

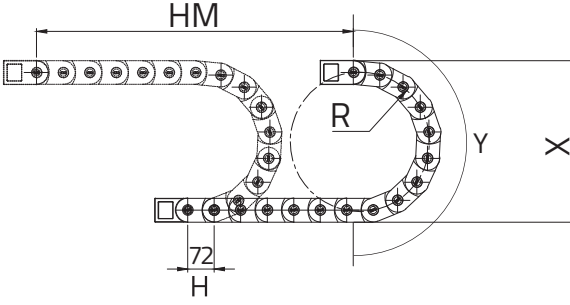

- L** Kullanılacak Miktar
Calculation of the Chain Length
- HM** Hareket Mesafesi
Movement Distance
- X** Montaj Yüksekliği
Mounting Height
- Y** Radyüs Mesafesi
Radius Distance
- H** Hatve
Pitch

$$L = HM / 2 + Y$$

$$X = R \times 2 + C$$

$$Y = R \times \pi$$

Kıvrılma Yarıçapı / Bending Radius	75	100	125	150	200	250	300
H (mm)	72	72	72	72	72	72	72
X (mm)	212	262	312	362	462	562	662
Y (mm)	236	314	392	471	628	785	942

* Kapalı ve Yarı Açık serilerin radiusleri 125'ten başlamaktadır /
The Closed Cover and Half Covered type product radius is started from R125

YÜK DİYAGRAMI LOAD DIAGRAM

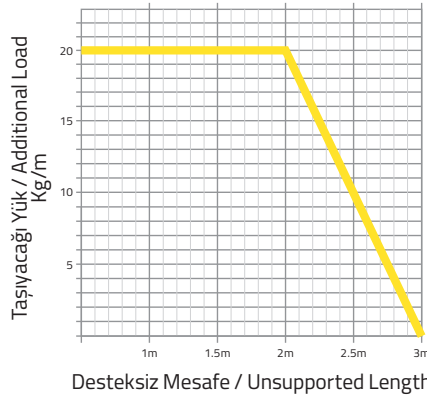

CK40 A SERİSİ

CK40 A SERIE

İçten ve Dıştan Açılabilir Seri
Openable From Inner and Outside

Örnek Ürün Kodu
Product No. Example

CK40

İç Yükseklik
Inner Height

A

Açık Seri
Open Serie

080

İç Genişlik
Inner Width

R100

Kıvrılma Yarıçapı
Bending Radius

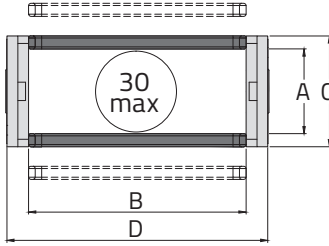

CK 40 A	A	B	C	D	R	W
MODEL	İç Yükseklik (mm) Inner Height (mm)	İç Genişlik (mm) Inner Width (mm)	Dış Yükseklik (mm) Outer Height (mm)	Dış Genişlik (mm) Outer Width (mm)	Kıvrılma Yarıçapı Bending Radius	Ağırlık Kg/Mt Weight Kg/Mt
CK40 A 080 R ...	40	80	62	108	75, 100, 125, 150, 200, 250, 300	2,348
CK40 A 100 R ...		100		128		2,516
CK40 A 120 R ...		120		148		2,684
CK40 A 140 R ...		140		168		2,824
CK40 A 160 R ...		160		188		2,936
CK40 A 180 R ...		180		208		3,048
CK40 A 200 R ...		200		228		3,272

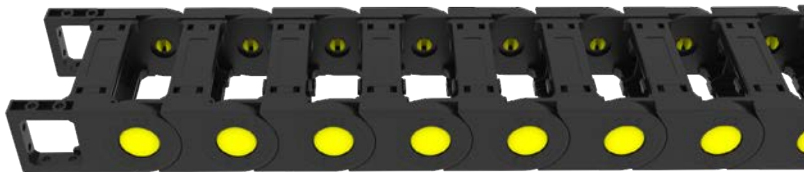

CK40 AL SERİSİ İçten ve Dıştan Açılabilir Seri CK40 AL SERIE Openable From Inner and Outside

Örnek Ürün Kodu
Product No. Example

CK40

İç Yükseklik
Inner Height

AL

Açık Seri
Open Serie

500

İç Genişlik
Inner Width

R300

Kıvrılma Yarıçapı
Bending Radius

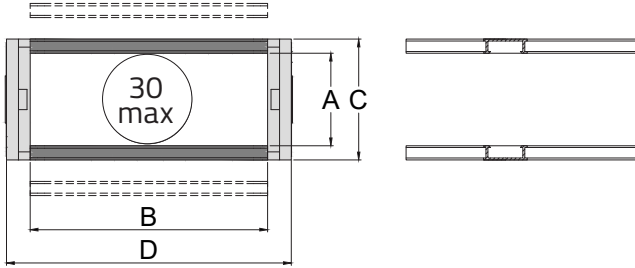

CK 40 AL	A	B	C	D	R	W
MODEL	İç Yükseklik (mm) Inner Height (mm)	İç Genişlik (mm) Inner Width (mm)	Dış Yükseklik (mm) Outer Height (mm)	Dış Genişlik (mm) Outer Width (mm)	Kıvrılma Yarıçapı Bending Radius	Ağırlık Kg/Mt Weight Kg/Mt
CK40 AL 250 R ...	40	250	62	278	75, 100, 125, 150, 200, 250, 300	3,552
CK40 AL 300 R ...		300		328		3,888
CK40 AL 400 R ...		400		428		4,560
CK40 AL 500 R ...		500		528		5,232

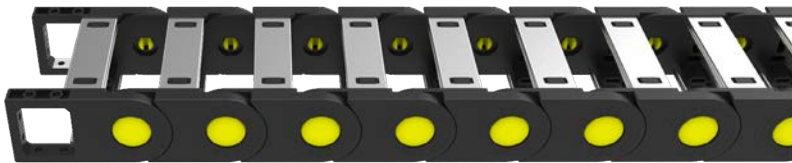

CK40 K SERİSİ

CK40 K SERIE

İçten ve Dıştan Açılabilir Seri
Openable From Inner and Outside

Örnek Ürün Kodu
Product No. Example

CK40

İç Yükseklik
Inner Height

K

Kapalı Seri
Closed Serie

100

İç Genişlik
Inner Width

R250

Kıvrılma Yarıçapı
Bending Radius

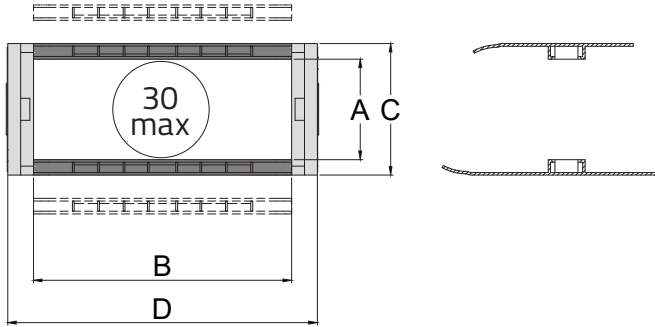

CK 40 K	A	B	C	D	R	W
MODEL	İç Yükseklik (mm) Inner Height (mm)	İç Genişlik (mm) Inner Width (mm)	Dış Yükseklik (mm) Outer Height (mm)	Dış Genişlik (mm) Outer Width (mm)	Kıvrılma Yarıçapı Bending Radius	Ağırlık Kg/Mt Weight Kg/Mt
CK40 K 100 R ...	40	100	62	128	125, 150, 200, 250, 300	2,810



CK40 Y SERİSİ

CK40 Y SERIE

İçten ve Dıştan Açılabilir Seri
Openable From Inner and Outside

Örnek Ürün Kodu
Product No. Example

CK40

İç Yükseklik
Inner Height

Y

Yarı Açık Seri
Half Covered Serie

100

İç Genişlik
Inner Width

R250

Kıvrılma Yarıçapı
Bending Radius

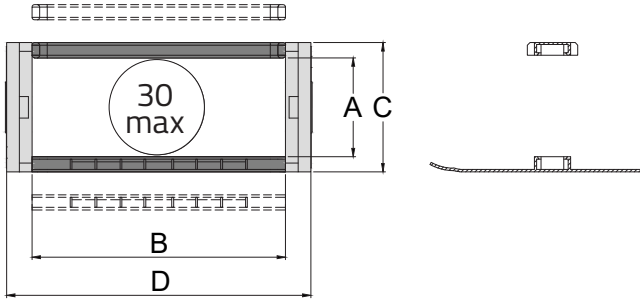

CK 40 Y	A	B	C	D	R	W
MODEL	İç Yükseklik (mm) Inner Height (mm)	İç Genişlik (mm) Inner Width (mm)	Dış Yükseklik (mm) Outer Height (mm)	Dış Genişlik (mm) Outer Width (mm)	Kıvrılma Yarıçapı Bending Radius	Ağırlık Kg/Mt Weight Kg/Mt
CK40 Y 100 R ...	40	100	62	128	125, 150, 200, 250, 300	2,600



Dikey Separatör Ölçüleri
Vertical Separator Dimensions

CK40 SP

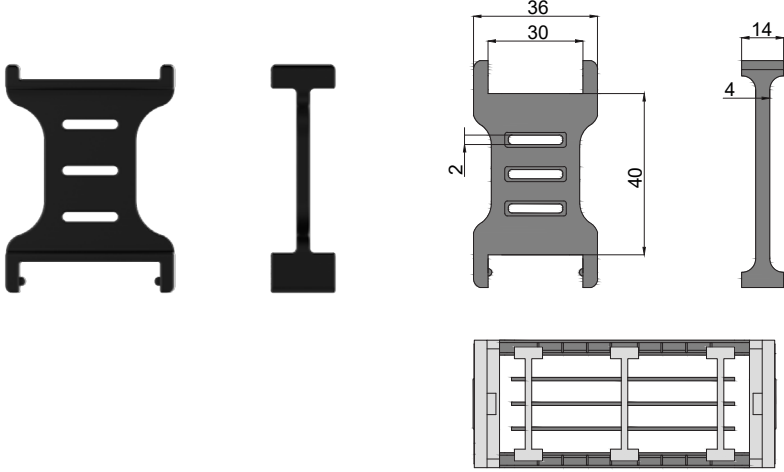

Yatay Separatör Ölçüleri
Horizontal Separator Dimensions

CK40 YSP

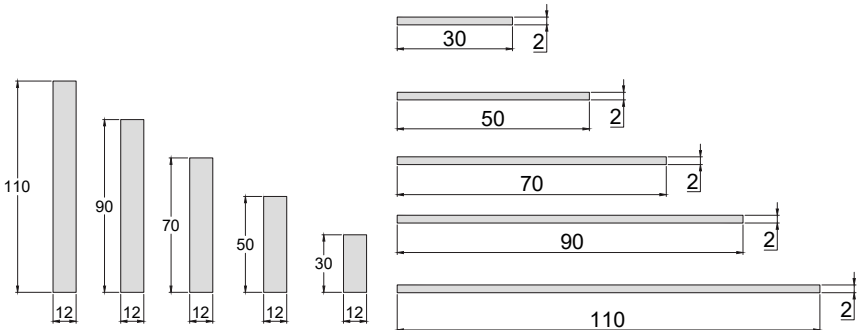

Plastik Ayak Montaj Ölçüleri

Plastic End Bracket Assembly Dimensions

CK40 P

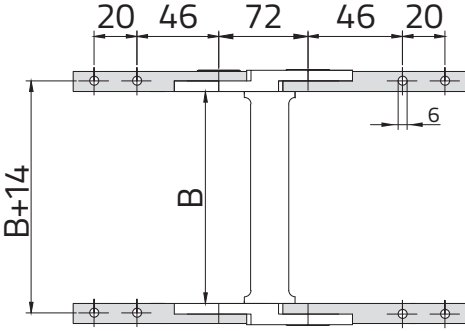

'B' ölçüsünü ölçü tablosundan bulabilirsiniz.
You will find the 'B' dimension from model table.

CK40 A



CK40 AL



CK40 K



CK40 Y

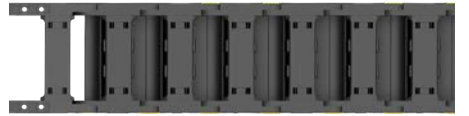

Plastik Ayak Montaj

Plastic End Bracket Assembly

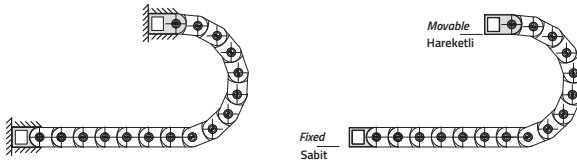

CK40 M

Metal Ayak Montaj Ölçüleri

Metal End Bracket Assembly Dimensions

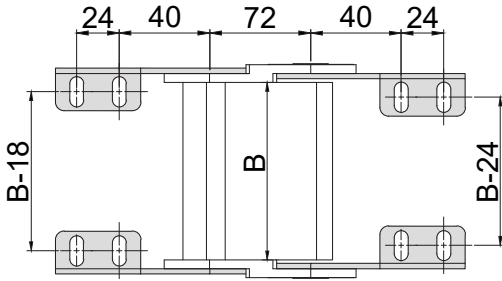

'B' ölçüsünü ölçü tablosundan bulabilirsiniz.
You will find the 'B' dimension from model table.

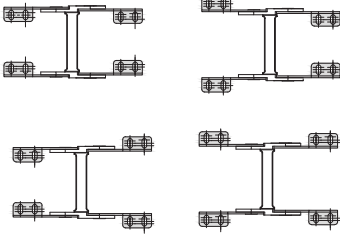

CK40 A



CK40 AL



CK40 K



CK40 Y



Metal Ayak Montaj

Metal End Bracket Assembly

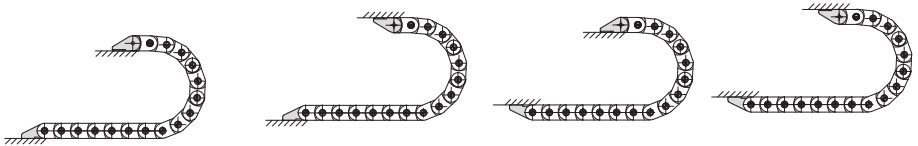

Montaj-Demontaj Uygulaması

Assembly-Disassembly Application

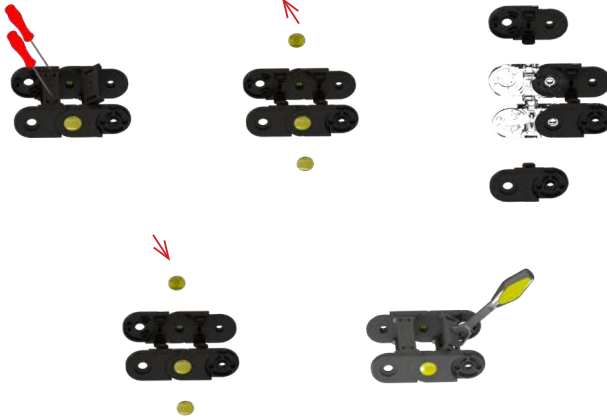

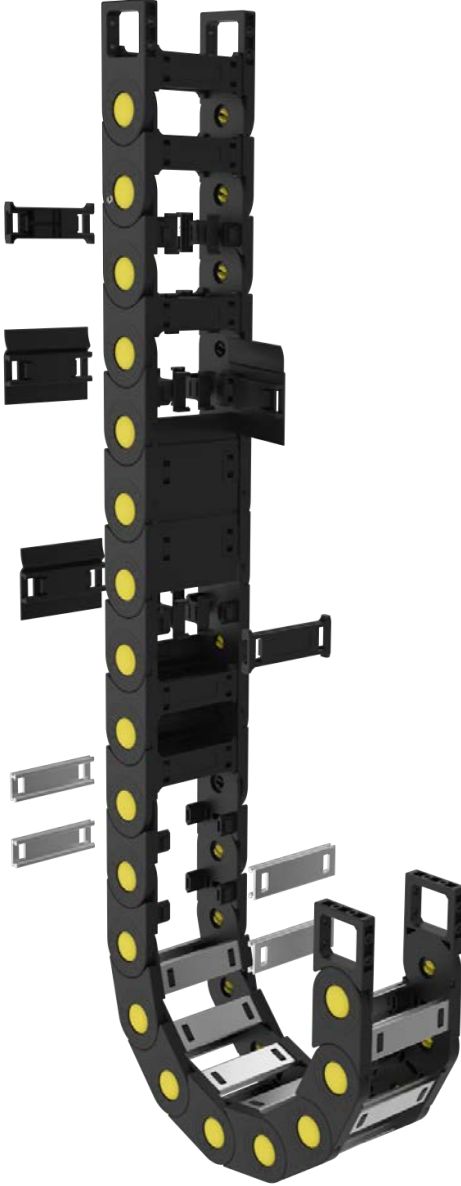

CK60 A SERİSİ
CK60 A SERIE

CK60 AL SERİSİ
CK60 AL SERIE

CK60 K SERİSİ
CK60 K SERIE

CK60 Y SERİSİ
CK60 Y SERIE

MALZEME ÖZELLİKLERİ

MATERIAL FEATURES

PA6 %30 Cam Elyaf
PA6 With %30 Fiber Glass

HIZ

SPEED

4 m/sn
4 m/sec

ÇALIŞMA SICAKLIĞI

OPERATING TEMPERATURE

-30°C ~ + 130°C

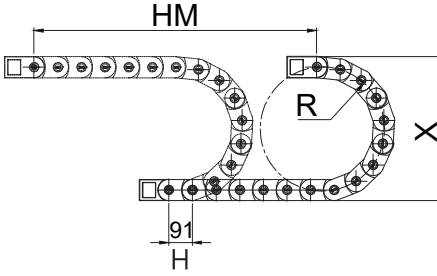

- L** Kullanılacak Miktar
Calculation of the Chain Length
- HM** Hareket Mesafesi
Movement Distance
- X** Montaj Yüksekliği
Mounting Height
- Y** Radyüs Mesafesi
Radius Distance
- H** Hatve
Pitch

$$L = HM / 2 + Y$$

$$X = R \times 2 + C$$

$$Y = R \times \pi$$

Kıvrılma Yarıçapı / Bending Radius	100	150	200	250	300
H (mm)	91	91	91	91	91
X (mm)	282	382	482	582	682
Y (mm)	314	471	628	785	942

* Kapalı ve Yarı Açık serilerin radiusleri 150'den başlamaktadır /
The Closed Cover and Half Covered type product radius is started from R150

YÜK DİYAGRAMI LOAD DIAGRAM

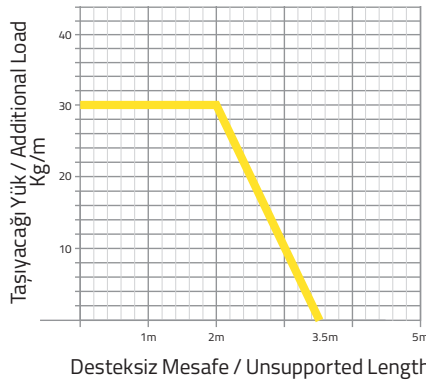

CK60 A SERİSİ

CK60 A SERIE

İçten ve Dıştan Açılabilir Seri
Openable From Inner and Outside

Örnek Ürün Kodu
Product No. Example

CK60

İç Yükseklik
Inner Height

A

Açık Seri
Open Serie

080

İç Genişlik
Inner Width

R100

Kıvrılma Yarıçapı
Bending Radius

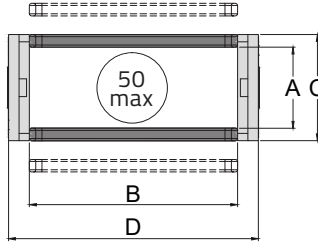

CK 60 A	A	B	C	D	R	W
MODEL	İç Yükseklik (mm) Inner Height (mm)	İç Genişlik (mm) Inner Width (mm)	Dış Yükseklik (mm) Outer Height (mm)	Dış Genişlik (mm) Outer Width (mm)	Kıvrılma Yarıçapı Bending Radius	Ağırlık Kg/Mt Weight Kg/Mt
CK60 A 080 R ...	60	80	82	112	100, 150, 200, 250, 300	3,120
CK60 A 100 R ...		100		132		3,252
CK60 A 120 R ...		120		152		3,384
CK60 A 140 R ...		140		172		3,494
CK60 A 160 R ...		160		192		3,582
CK60 A 180 R ...		180		212		3,670
CK60 A 200 R ...		200		232		3,846

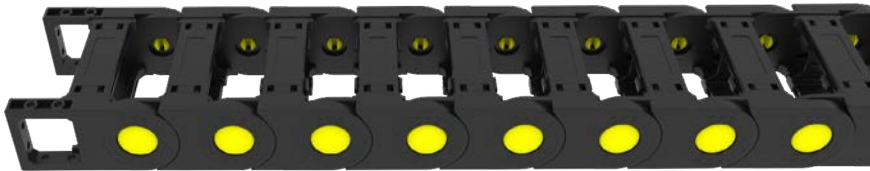

CK60 AL SERİSİ İçten ve Dıştan Açılabilir Seri CK60 AL SERIE Openable From Inner and Outside

Örnek Ürün Kodu
Product No. Example

CK60

İç Yükseklik
Inner Height

AL

Açık Seri
Open Serie

500

İç Genişlik
Inner Width

R300

Kıvrılma Yarıçapı
Bending Radius

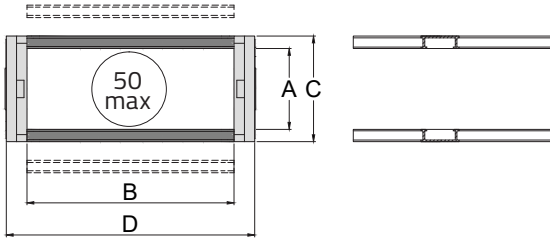

CK 60 AL	A	B	C	D	R	W
MODEL	İç Yükseklik (mm) Inner Height (mm)	İç Genişlik (mm) Inner Width (mm)	Dış Yükseklik (mm) Outer Height (mm)	Dış Genişlik (mm) Outer Width (mm)	Kıvrılma Yarıçapı Bending Radius	Ağırlık Kg/Mt Weight Kg/Mt
CK60 AL 250 R ...	60	250	82	282	100, 150, 200, 250, 300	4,065
CK60 AL 300 R ...		300		332		4,330
CK60 AL 400 R ...		400		432		4,858
CK60 AL 500 R ...		500		532		5,386



CK60 K SERİSİ

CK60 K SERIE

İçten ve Dıştan Açılabilir Seri
Openable From Inner and Outside

Örnek Ürün Kodu
Product No. Example

CK60

İç Yükseklik
Inner Height

K

Kapalı Seri
Closed Serie

100

İç Genişlik
Inner Width

R250

Kıvrılma Yarıçapı
Bending Radius

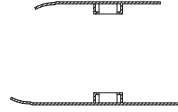
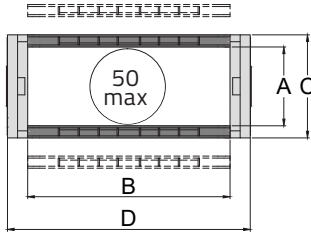

CK 60 K	A	B	C	D	R	W
MODEL	İç Yükseklik (mm) Inner Height (mm)	İç Genişlik (mm) Inner Width (mm)	Dış Yükseklik (mm) Outer Height (mm)	Dış Genişlik (mm) Outer Width (mm)	Kıvrılma Yarıçapı Bending Radius	Ağırlık Kg/Mt Weight Kg/Mt
CK60 K 100 R ...	60	100	82	132	150, 200, 250, 300	3,681
CK60 K 140 R ...	60	140	82	172		4,088
CK60 K 200 R ...	60	200	82	232		4,649



CK60 Y SERİSİ

CK60 Y SERIE

İçten ve Dıştan Açılabilir Seri
Openable From Inner and Outside

Örnek Ürün Kodu
Product No. Example

CK60

İç Yükseklik
Inner Height

Y

Yarı Açık Seri
Half Covered Serie

100

İç Genişlik
Inner Width

R250

Kıvrılma Yarıçapı
Bending Radius

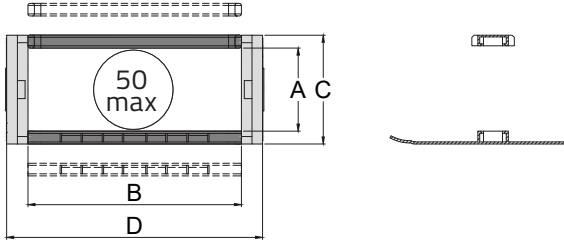

CK 60 Y	A	B	C	D	R	W
MODEL	İç Yükseklik (mm) Inner Height (mm)	İç Genişlik (mm) Inner Width (mm)	Dış Yükseklik (mm) Outer Height (mm)	Dış Genişlik (mm) Outer Width (mm)	Kıvrılma Yarıçapı Bending Radius	Ağırlık Kg/Mt Weight Kg/Mt
CK60 Y 100 R ...	60	100	82	132	150, 200, 250, 300	3,417
CK60 Y 140 R ...	60	140	82	172		3,736
CK60 Y 200 R ...	60	200	82	232		4,220



Dikey Separatör Ölçüleri
Vertical Separator Dimensions

CK60 SP

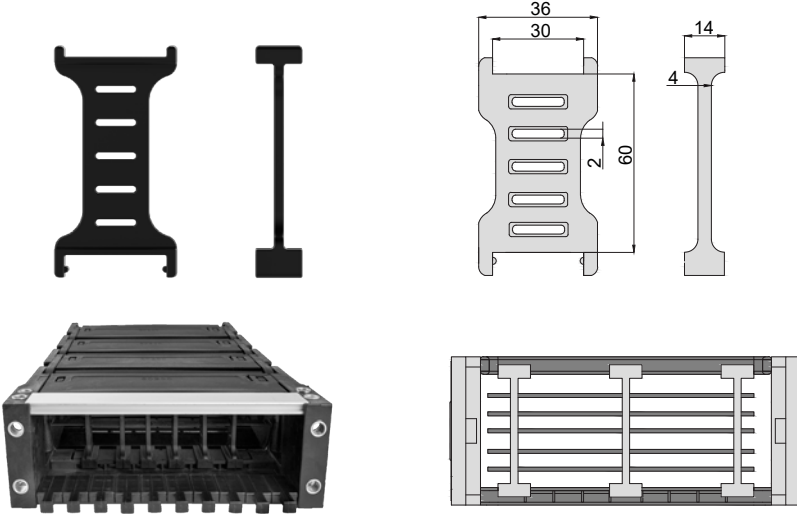

Yatay Separatör Ölçüleri
Horizontal Separator Dimensions

CK60 YSP

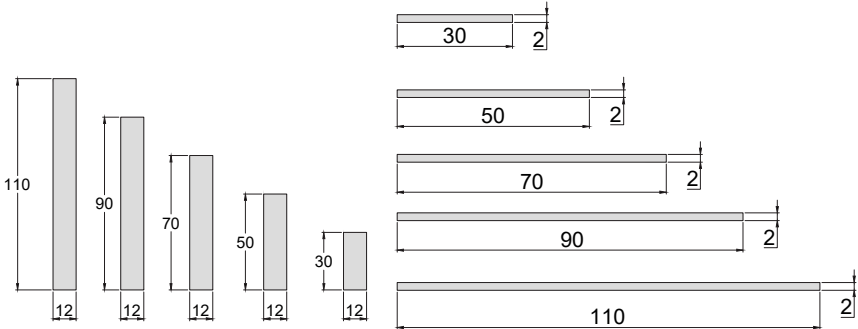

Plastik Ayak Montaj Ölçüleri

Plastic End Bracket Assembly Dimensions

CK60 P

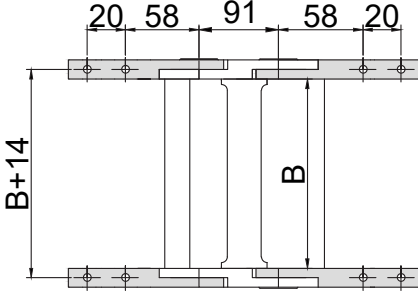

'B' ölçüsünü ölçü tablosundan bulabilirsiniz.
You will find the 'B' dimension from model table.

CK60 A



CK60 AL



CK60 K



CK60 Y

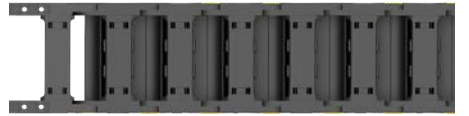

Plastik Ayak Montaj

Plastic End Bracket Assembly

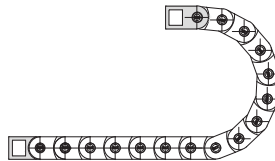

Metal Ayak Montaj Ölçüleri

Metal End Bracket Assembly Dimensions

CK60 M

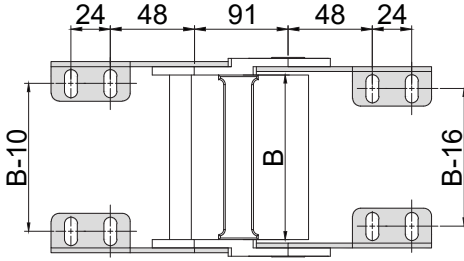

'B' ölçüsünü ölçü tablosundan bulabilirsiniz.
You will find the 'B' dimension from model table.

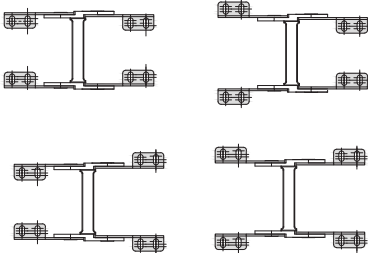

CK60 A



CK60 AL



CK60 K



CK60 Y

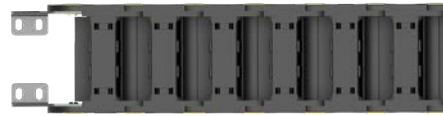

Metal Ayak Montaj

Metal End Bracket Assembly

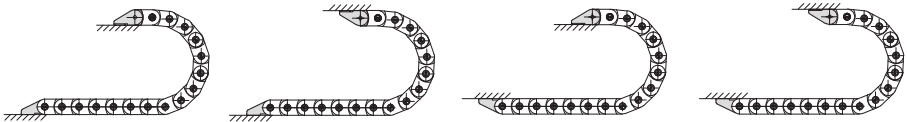

Kablo Sabitleyici *Strain Relief*

CK60 SR

CK SR 1

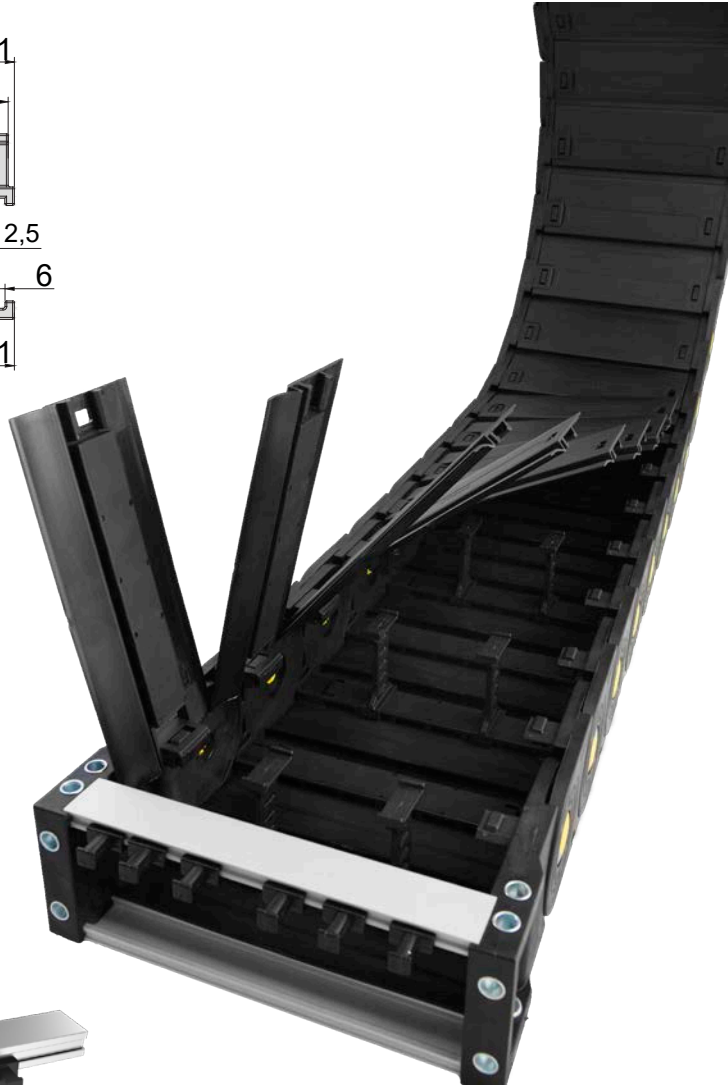
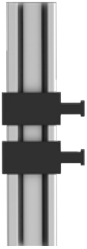
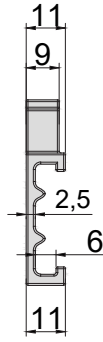
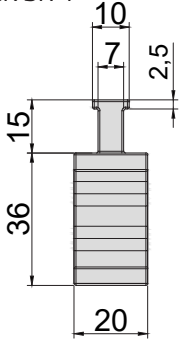



CK80 A SERİSİ
CK80 A SERIE

CK80 AL SERİSİ
CK80 AL SERIE

MALZEME ÖZELLİKLERİ

MATERIAL FEATURES

PA6 %30 Cam Elyaf
PA6 With %30 Fiber Glass

HIZ

SPEED

4 m/sn
4 m/sec

ÇALIŞMA SICAKLIĞI

OPERATING TEMPERATURE

-30°C ~ + 130°C

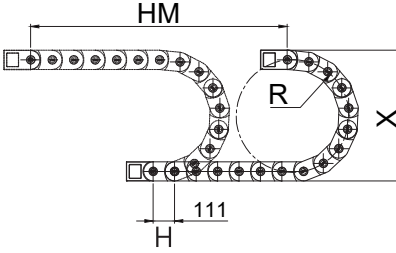

- L** Kullanılacak Miktar
Calculation of the Chain Length
- HM** Hareket Mesafesi
Movement Distance
- X** Montaj Yüksekliği
Mounting Height
- Y** Radüs Mesafesi
Radius Distance
- H** Hatve
Pitch

$$L = HM / 2 + Y$$

$$X = R \times 2 + C$$

$$Y = R \times \pi$$

Kıvrılma Yarıçapı / Bending Radius	150	200	250	300
H (mm)	111	111	111	111
X (mm)	402	502	602	702
Y (mm)	471	628	785	942

YÜK DİYAGRAMI LOAD DIAGRAM

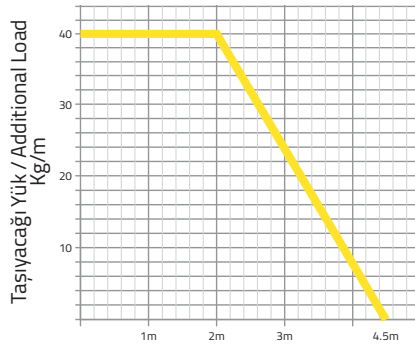

Desteksiz Mesafe / Unsupported Length

CK80 A SERİSİ

CK80 A SERIE

İçten ve Dıştan Açılabilir Seri
Openable From Inner and Outside

Örnek Ürün Kodu
Product No. Example

CK80

İç Yükseklik
Inner Height

A

Açık Seri
Open Serie

200

İç Genişlik
Inner Width

R200

Kıvrılma Yarıçapı
Bending Radius

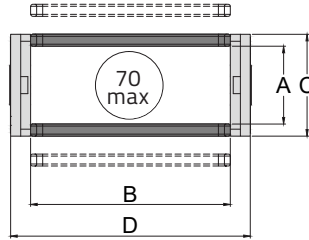

CK 80 A	A	B	C	D	R	W
MODEL	İç Yükseklik (mm) Inner Height (mm)	İç Genişlik (mm) Inner Width (mm)	Dış Yükseklik (mm) Outer Height (mm)	Dış Genişlik (mm) Outer Width (mm)	Kıvrılma Yarıçapı Bending Radius	Ağırlık Kg/Mt Weight Kg/Mt
CK80 A 080 R ...	80	80	102	112	150, 200, 250, 300	3,384
CK80 A 100 R ...		100		132		3,492
CK80 A 120 R ...		120		152		3,600
CK80 A 140 R ...		140		172		3,690
CK80 A 160 R ...		160		192		3,762
CK80 A 180 R ...		180		212		3,834
CK80 A 200 R ...	200	232	3,978			



CK80 AL SERİSİ İçten ve Dıştan Açılabilir Seri CK80 AL SERIE Openable From Inner and Outside

Örnek Ürün Kodu
 Product No. Example

CK80

İç Yükseklik
 Inner Height

AL

Açık Seri
 Open Serie

400

İç Genişlik
 Inner Width

R300

Kıvrılma Yarıçapı
 Bending Radius

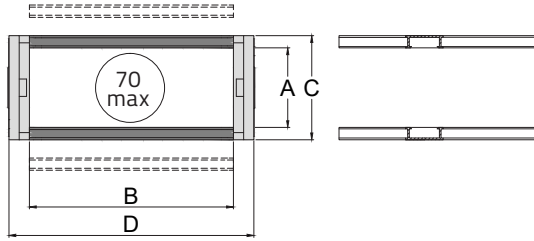

CK 80 AL	A	B	C	D	R	W
MODEL	İç Yükseklik (mm) Inner Height (mm)	İç Genişlik (mm) Inner Width (mm)	Dış Yükseklik (mm) Outer Height (mm)	Dış Genişlik (mm) Outer Width (mm)	Kıvrılma Yarıçapı Bending Radius	Ağırlık Kg/Mt Weight Kg/Mt
CK80 AL 250 R ...	80	250	102	282	150, 200, 250, 300	4,158
CK80 AL 300 R ...		300		332		4,374
CK80 AL 400 R ...		400		432		4,806
CK80 AL 500 R ...		500		532		5,238



Metal Ayak Montaj Ölçüleri

Metal End Bracket Assembly Dimensions

CK80 M

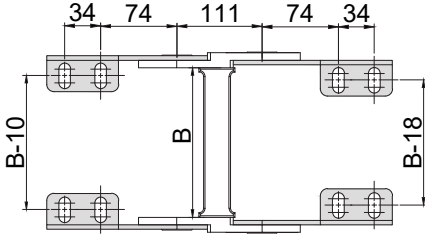

'B' ölçüsünü ölçü tablosundan bulabilirsiniz.
You will find the 'B' dimension from model table.

CK80 A



CK80 AL

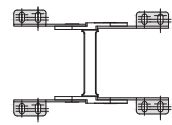
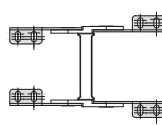
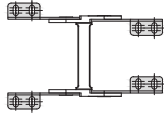
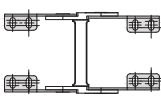

Metal Ayak Montaj

Metal End Bracket Assembly

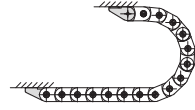
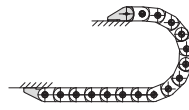
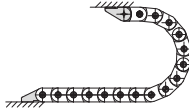
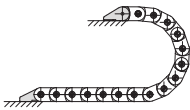

Dikey Separatör Ölçüleri

Vertical Separator Dimensions

CK80 SP

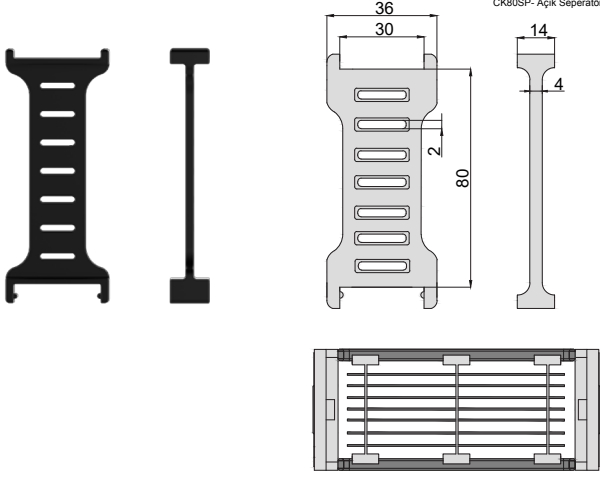

Yatay Separatör Ölçüleri

Horizontal Separator Dimensions

CK80 YSP

